

Article number: 604144072085

Description: Timing belt pulley with hub
HTD 72 8M 85

Measures

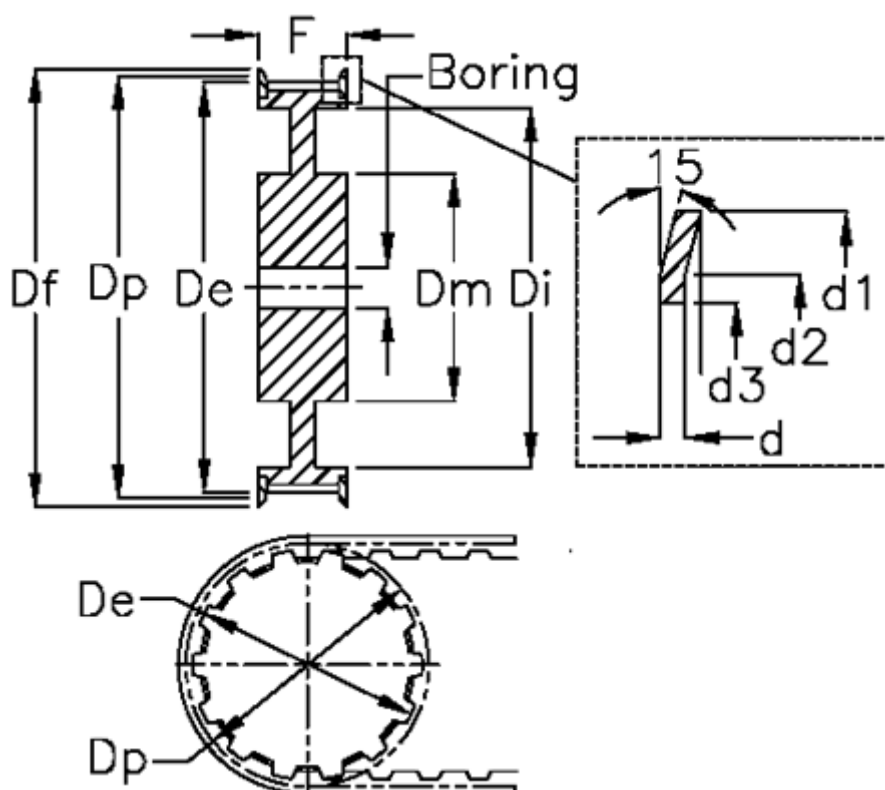

Bore = 20	Dm = 100	Width = 85
d = 1.5	Dp = 183.35	
d1 = 192	F = 158	
d2 = 187	Flange type = F57	
d3 = 173	L = 95	
De = 181.97	Tooth number = 72	
Df = 192	Type = 8M	
Di = 95	Weight = 11.4	